



Lane Gard 3™ and Anchor® Mast Type III Barricade Systems Product Guide



LaneGard³

FOLDING TYPE III BARRICADE

One-piece design sets up and tears down in seconds.

FHWA Acceptance Letter: WZ-336

Tested to Manual for
Assessing Safety Hardware
(MASH) Guidelines, Test Level 3



Optional Anti-Skid Feet, 2 per Cross-Bar.

Folds for storage and transport, unfolds for use.



One person can easily fold and unfold LaneGard 3.



LaneGard 3 shown folded, with 6' PSS Wave Centerboards attached.

LaneGard³

FOLDING TYPE III BARRICADE

LaneGard 3 Upright Features:

- LaneGard 3 folds for transport and storage, with PSS Wave Centerboards attached. Unfolds for deployment.
- Made from engineered plastic with UV inhibitors.
- Weighs 17 lbs. assembled, without centerboards.
- Molded-in Warning Light Mount accepts LED Type A and C Warning Lights.
- Molded through-holes recessed for flush-mounted hardware.
- Designed for use with PSS Wave Centerboards.
- Wave Centerboard available in 4', 6', 8' lengths.
- Retroreflective sheeting available in Engineer, Hi-Intensity and Diamond Grades.
- Retroreflective sheeting meets all state and federal specifications. Available in Engineer, Hi-Intensity and Diamond grades.



Accepts Type A and C LED Warning Lights.

Measures less than 3" thick when folded for transport or storage.

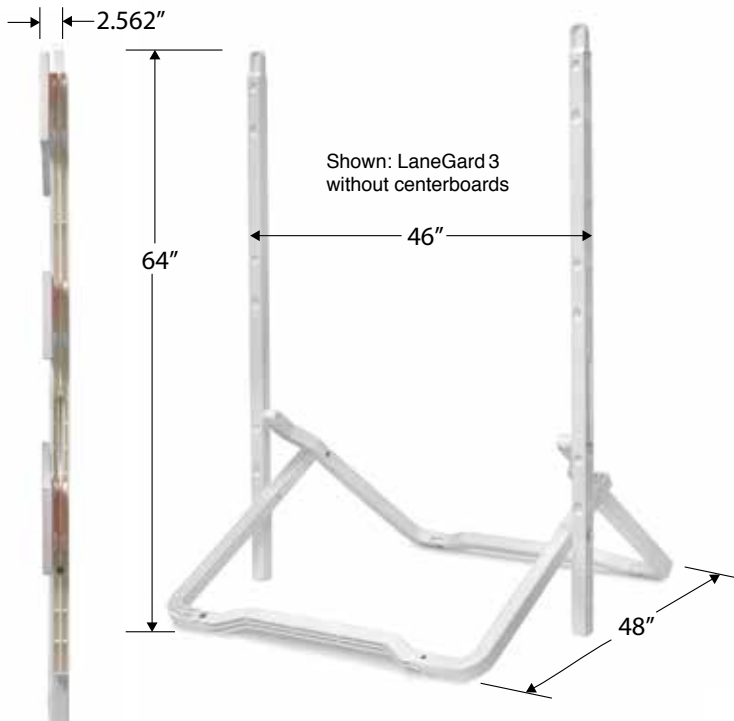

US Patent No. 9,297,127.

Use sandbags (shown above) or PSS Rubber Tire Collars (below) for Additional Ballast!



We use 3M Reflective Sheeting.

LaneGard³

FOLDING TYPE III BARRICADE

Assembly Instructions

Parts List

Base Hardware

- 2 - Pre-assembled Uprights
- 2 - Cross-Bars
- 4 - 1/4-20 x 1.5" Hex-Bolts
- 4 - Flat Washers
- 4 - Lock Nuts

Wave Panel Hardware

- 12 - 1/4-20 x 2" Hex-Bolts
 - 12 - Flat Washers
 - 12 - Pallet Nuts
- Tools required:
Ratchet with a 7/16" socket
1/4" Allen Wrench (Hex Key)

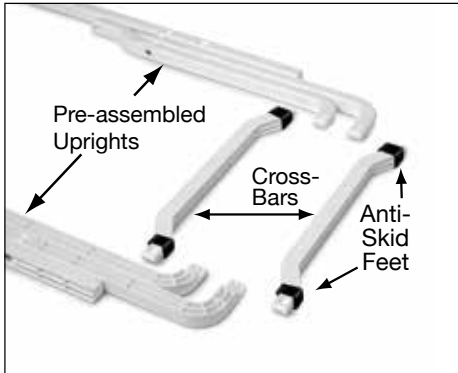

Step 1 - Layout parts as shown here. Attach optional Anti-Skid Feet (2 per cross-bar) prior to assembly, as shown above.



Step 2 - Connect the 2 ends of the Cross-Bars to the Front and Back Legs using 1/4-20 x 1.5" bolts, washers and lock nuts. Make sure hex head bolt fits into hex head pocket on the upright.



After Step 3 - Assembly should now look like this. Assemble the centerboards on the front side of the Up-Right Assembly.



Step 3 - To unfold LaneGard 3: stand assembled unit up and open the legs. Push the upper cross bar away from you with your foot. Open the legs completely until the back leg locks in the open position.

LaneGard³

FOLDING TYPE III BARRICADE

Assembly Instructions



Step 4 - Attach boards to front side of Up-Right Assembly as shown here. Attach bottom board first; start with top hole on Upright for each board. Install boards using Pallet Nuts, 1/4-20 x 2" bolts, and washers. Insert hex head bolt and washer through Upright and centerboard into the Pallet Nut. Keep Pallet Nut from turning by using the 1/4" hex key. Tighten bolts with ratchet until snug.

Transport and Storage

To fold for transport and storage: pull the legs inward and upward, as shown below, then fold the device:



Folds flat with PSS Wave Centerboards attached.

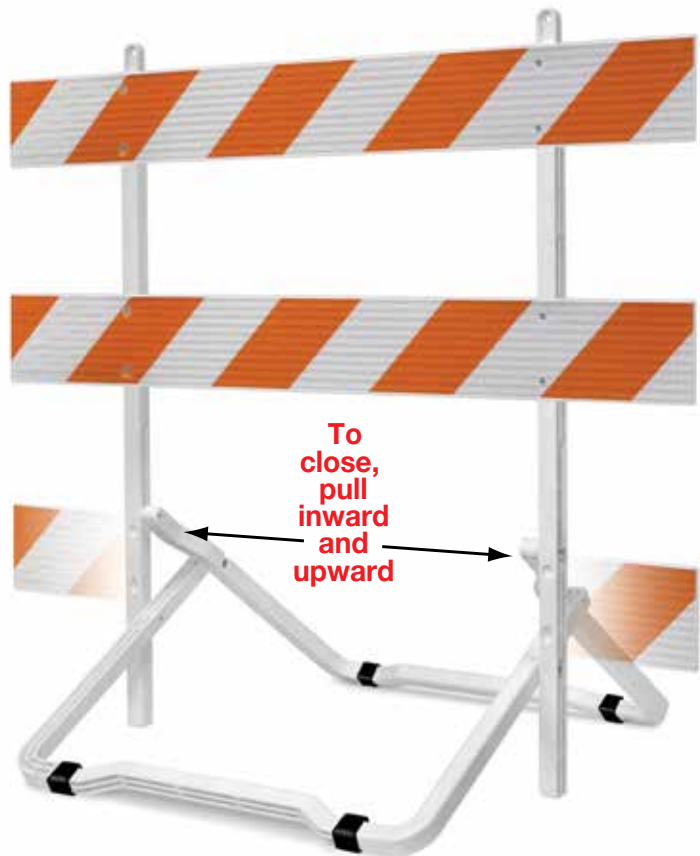

Anchor[®] Mast[®] Type III Barricade System

ANCHOR BASE - MAST UPRIGHT - WAVE CENTERBOARD

Durable. Lightweight. Available as a complete unit or as components.

Mast[®] Upright

For faster, easier assembly.

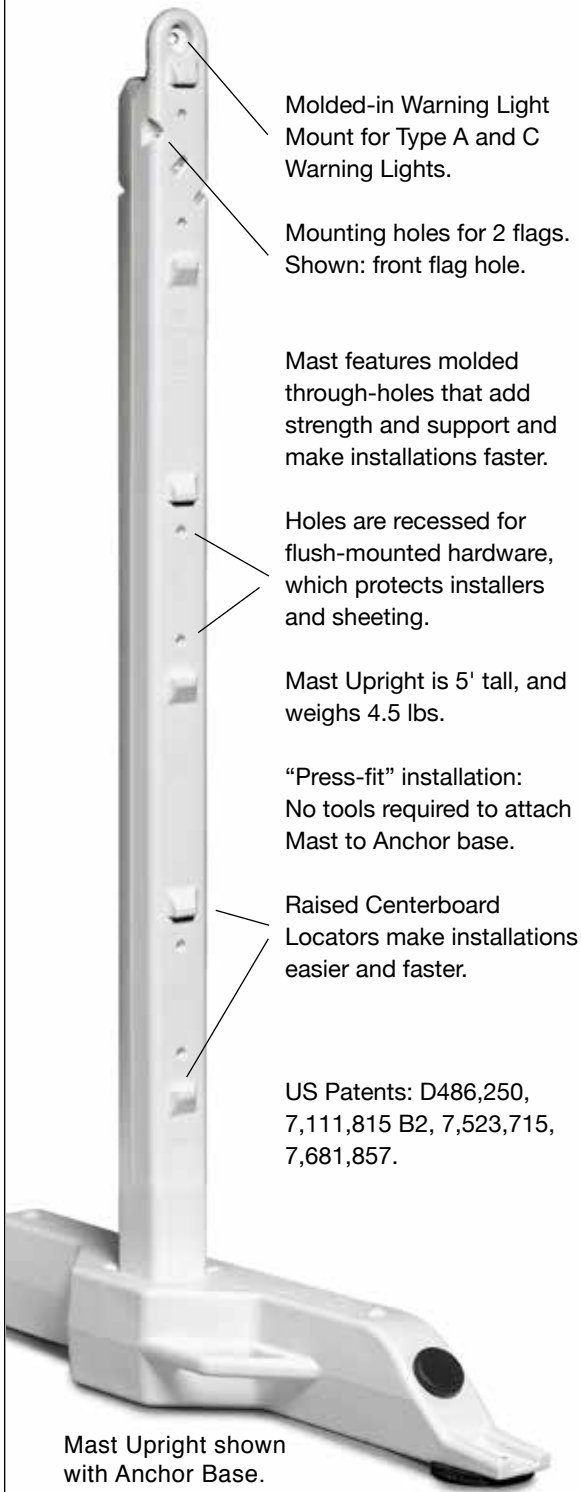

Molded-in Warning Light Mount for Type A and C Warning Lights.

Mounting holes for 2 flags. Shown: front flag hole.

Mast features molded through-holes that add strength and support and make installations faster.

Holes are recessed for flush-mounted hardware, which protects installers and sheeting.

Mast Upright is 5' tall, and weighs 4.5 lbs.

"Press-fit" installation: No tools required to attach Mast to Anchor base.

Raised Centerboard Locators make installations easier and faster.

US Patents: D486,250, 7,111,815 B2, 7,523,715, 7,681,857.

Mast Upright shown with Anchor Base.

Anchor Mast



Shown with 8' Wave Centerboards.

Manufactured from high density polyethylene plastic with UV-stabilizers.

NCHRP-350 certified and MUTCD compliant, Anchor Mast Barricade has earned several FHWA Acceptance Letters. Please visit our Anchor Mast Barricade page to download WZ-244, an FHWA Acceptance Letter that contains a list of all FHWA Letters for PSS Anchor Mast Type III Barricade.

Download Anchor Mast WZ-244 letter



Anchor[®] Base

Eliminates sand bags.

Available in 2 lengths: Anchor 48" (holds 45 lbs. of sand) or Anchor 60" (holds 60 lbs. of sand).

"Press-fit" installation of Mast and other 4" x 4" plastic uprights.



We use 3M Reflective Sheeting.

Wave® Plastic Centerboard

Designed with Anchor Mast Upright for a close-tolerance barricade system.



Wave Centerboard is blow-molded from UV-stabilized high density polyethylene plastic, with a reinforced structure.

Available in 4', 6', and 8' lengths.

Wave design:

- strengthens and stiffens the centerboard
- reduces sagging and warping
- greatly improves reboundability

Retroreflective sheeting meets all state and federal specifications, and is available in Engineer, Hi-Intensity and Diamond grades.

FHWA Acceptance Letter WZ-173 and WZ-244.
US Patent No. 7,536,973.



Wave Centerboard Features:

- Closed ends prevent dirt and moisture from collecting and prevent bees and hornets from building nests.
- Molded through-holes that add strength and support and make installations faster.
- Holes are recessed for flush-mounted hardware, which protects installers and sheeting.

Anchor® Type III Base for Steel Uprights

REPURPOSE EXISTING STEEL UPRIGHT INVENTORY.

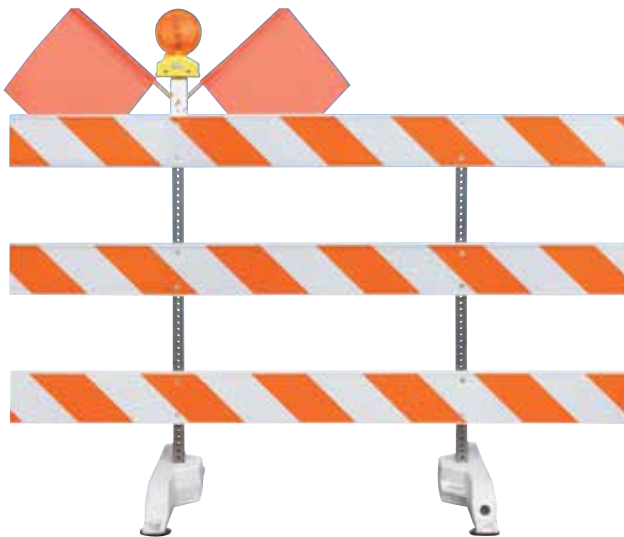

Available in 48" or 60" lengths.

Designed for 1 3/4" steel uprights and other 1 3/4" metal or plastic uprights.

Anchor Bases for steel uprights available in 48" or 60" lengths.

Provide the same fast press-fit installation as Anchor Base for plastic uprights.

Shown with Light and Flag Mount Accessory.

PSS does not manufacture or market steel uprights.

Light and Flag Mount (LFM) Accessory

Add lights and flags to steel uprights quickly and easily.

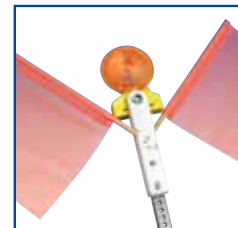

Each LFM accepts 1 or 2 flags and 1 warning light.

Installs easily on 1 3/4" steel uprights with normal hardware.

LFM also fits 2 or 3 lb. U-Channel uprights.



Shown: Back of LFM.

LFM fits inside an extruded 4" x 4" upright with no additional hardware required.

Manufactured from high density polyethylene (HDPE) plastic with UV-stabilizers.

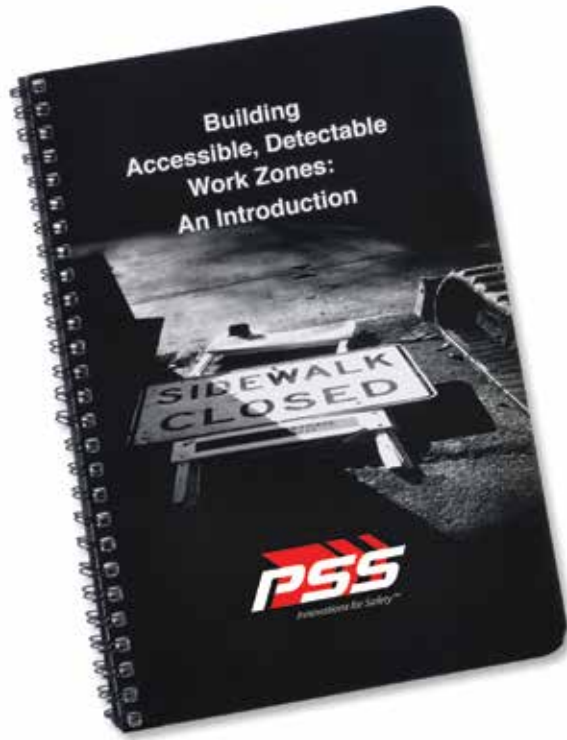

Building Accessible, Detectable Work Zones

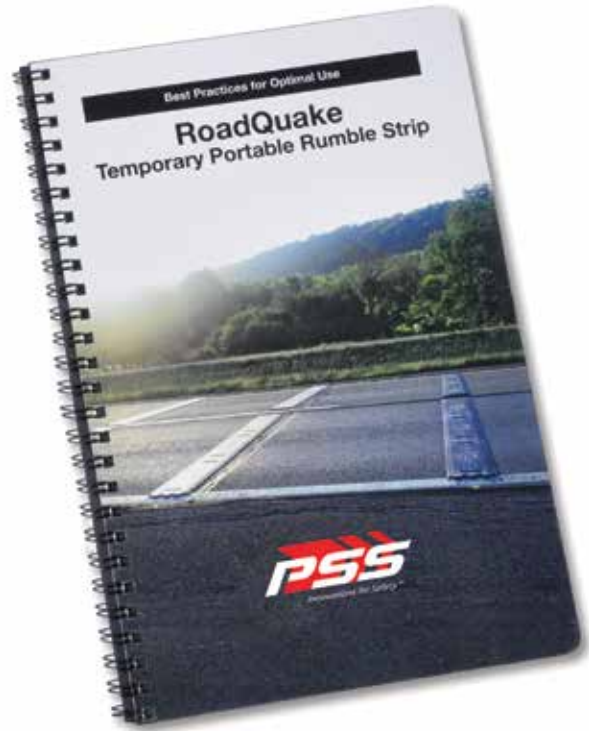

Best Practices for Optimal Use of RoadQuake TPRS

Please contact us for a complimentary copy of our guide books.



Innovations for Safety™

PSS
2444 Baldwin Road
Cleveland OH 44104
800-662-6338
PSS-Innovations.com

Distributed by:

Contact PSS Sales

