



ADA-Compliant Devices Product Guide



Innovations for Safety®

TABLE OF CONTENTS:

PAGE 04	ADA-COMPLIANT DEVICES
PAGE 05	INTRODUCTION TO RIGHTPATH™
PAGE 06	BOARDWALK RAMP
PAGE 07	BOARDWALK PLATFORM
PAGE 08	BOARDWALK SYSTEM
PAGE 10	COMMON BOARDWALK CONFIGURATIONS

PAGE 12	BOARDWALK BRIDGE
PAGE 14	RAPIDRAMP™ THE ADA EXPRESS RAMP
PAGE 16	SAFETYWALL™ PEDESTRIAN BARRICADE
PAGE 18	SAFETYRAIL™ PEDESTRIAN BARRICADE
PAGE 20	PARAKEET™ AUDIBLE INFORMATION DEVICE

WHO WE ARE

WE ARE PSS:

For over 40 years, PSS has crafted breakthrough solutions that can safeguard worksites and save lives. We are powered by dedicated, creative people and fueled by continuous innovation.

Our focus is on the right-of-way — that point in time and place where motorists, workers, and pedestrians intersect and interact. Our goal is to design products and services that provide safe travels so that everyone can return home safely at the end of the day.

We don't just talk about Innovations for Safety® — we live it. We believe that bold ideas and hard work produce outstanding results.

Our important work on, around, and through the right-of-way will result in real solutions for real people. Through continuous innovation and with consultation, education, and training, we work to save lives today, tomorrow, and for decades to come.



ADA-COMPLIANT DEVICES

INNOVATIONS IN PEDESTRIAN SAFETY:

In late 2007, PSS participated in the “Detectable Pedestrian Channelization” Workshop, an event co-sponsored by Maryland DOT, FHWA, and the U.S. Access Board. At the workshop, evaluators, blind or visually impaired (BVI) volunteers, reviewed commercially available pedestrian delineation devices exhibited by invited manufacturers.

Evaluators reviewed the detectable features of the devices. Orientation and mobility specialists recorded their comments and answers to a nine-question survey.

According to the final workshop report, evaluators’ findings were mixed. For example, while generally satisfied with the devices, evaluators were concerned that some could entrap cane tips.

The report further states that “...the exchange of information between evaluators and manufacturers was the most helpful outcome of the day. Few manufacturers or highway engineers [understood]...the techniques or orientation and mobility – that is, independent travel without vision cues – and all valued the opportunity to observe and question.”

About one year after the workshop, we introduced SafetyRail Barricade, our first ADA-Compliant, temporary traffic control device. SafetyWall Channelizer and BoardWalk RAMP followed shortly thereafter.

Many engineers and designers have replaced non-compliant sidewalk closure devices (Figure 1) with compliant ones, such as SafetyWall Channelizer and BoardWalk RAMP (Figure 2).



INTRO TO RIGHTPATH

INNOVATIONS IN PEDESTRIAN SAFETY:

For pedestrians, temporary pathways through construction work zones can be as hazardous as walking through the construction itself. Pedestrian guidance through or around a sidewalk work zone can be confusing, incomplete, or non-existent. Absent real guidance, pedestrians may be left to determine their own way through a work zone and could make unsafe decisions.

The foundation for safe, temporary pedestrian pathways is built on reliable, continuous, and detectable guidance to lead pedestrians unimpeded to their destination.

The PSS RightPath line of ADA-compliant work zone devices ensures that pedestrians and other vulnerable road users can travel in safety.

PSS takes pride in the constant innovation of our devices as we work to make travel safer for all, and the RightPath line of pedestrian safety devices is no exception. Offerings such as our BoardWalk RAMP & Platform system have been carefully engineered to accommodate all kinds of pedestrians and its modular design ensures that it can be configured to fit a wide range of unique work zone needs.

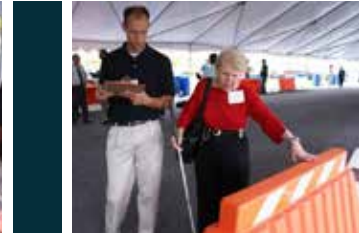

BOARDWALK RAMP

TEMPORARY PEDESTRIAN MODULAR RAMP:

BoardWalk RAMP provides accessible, detectable, and safe guidance where temporary access routes cross curbs at locations other than permanent sidewalk crossings. BoardWalk RAMP is installed perpendicular to the curb.

BoardWalk RAMP replaces curb transitions and temporary ramps that are non-compliant.

ADA-COMPLIANT FEATURES:

- » Provides 1" rise for 12" run.
- » Modular Edge Support Castings provide guidance for canes and walkers. Castings accommodate handrails, which provide detectable guidance.
- » Modular Edge Support Castings accommodate handrail assemblies.
- » Provided lumber has a slip-resistant surface.
- » Innovative design allows for normal water drainage.
- » Approach Plates are 48" W x 18" L and feature slip-resistant surface. 48" width is wheelchair friendly.

MODULAR FEATURES:

- » Modular sections connect for ramp length needed. No hardware required. Ramp rated at 800 lbs. capacity for 48" maximum width. Sections weigh 30 lbs.
- » Modular cast-iron Edge Support Castings measure 8" x 12". Designed for 2" x 6" lumber.
- » Metal Approach Plates feature slip-resistant tape.

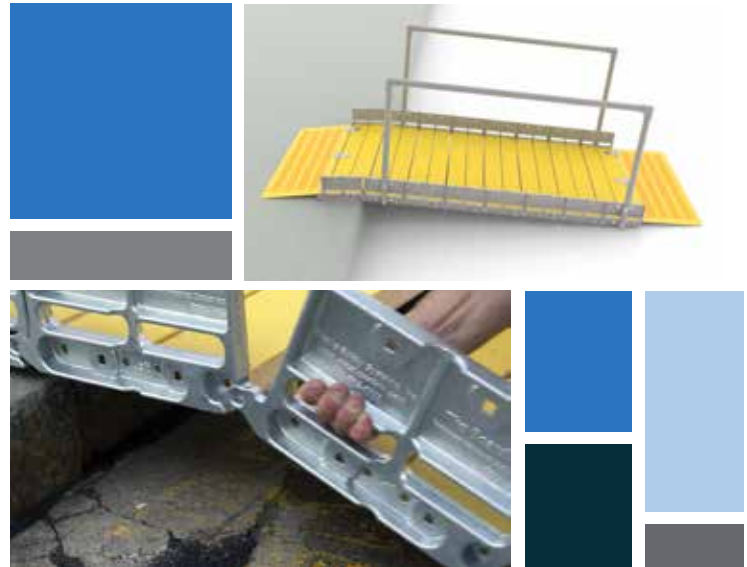

Patents: <http://bit.ly/3cHVTp8>

BOARDWALK PLATFORM

BOARDWALK BI-DIRECTIONAL PLATFORM:

BoardWalk Bi-Directional Platform is designed for use with BoardWalk RAMP when the alternate pedestrian pathway is parallel to the curb or sidewalk.

PLATFORM FEATURES:

Platform features the same components as BoardWalk RAMP. See previous page.

Platform measures 4' x 5' and is wheelchair friendly.

Four adjustable Screw Jacks support the Platform, and can accommodate curb heights from 2" to 14". For RAMPs exceeding nine sections use a Midway Support, as shown on Page 12.

The Platform is easily converted from left-turning to right-turning orientation. To change the guiding direction, attach the Moveable Detectable Edge and the horizontal handrail to the corresponding side of the platform. See Figure A.

Figure B shows BoardWalk RAMP with Bi-Directional Platforms installed in the curb lane parallel to the sidewalk. The curb lane serves as the temporary pedestrian pathway. The RAMP and the Platform are installed at either end of the sidewalk closure.

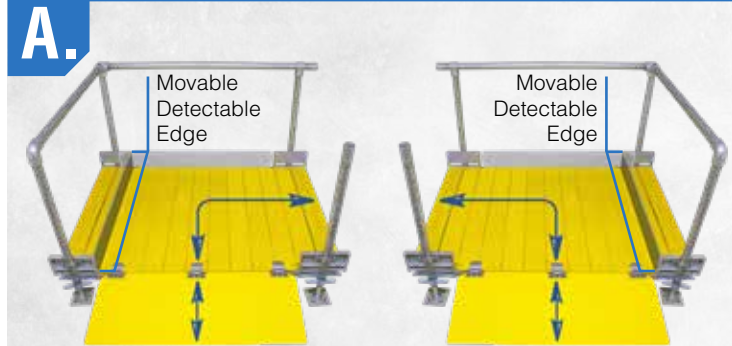

BOARDWALK SYSTEM

RAMP HEIGHT SPECIFICATIONS:

The correct ramp slope is a 1:12 ratio.

The number of modular ramp sections determines the slope of BoardWalk RAMP. The number of sections differs when using BoardWalk RAMP or BoardWalk RAMP and Platform. The number of sections required is not the same.

To determine the correct number of ramp sections for either BoardWalk RAMP or RAMP with Platform:

- » Which orientation of ramp do you require?
- » What is the height of the curb at the installation site?



Perpendicular to Curb



Parallel to Curb

With those questions answered, use the chart to determine the number of sections required per ramp orientation.

To maintain a 1:12 ratio, how many RAMP sections are needed?

Curb Height (In.)	Perpendicular	Parallel
1	3	N/A
2	4	3
3	5	3
4	6	3
5	7	4
6	8	5
7	9	6
8	10*	7
9	11*	8
10	12*	9
11	13*	10*
12	14*	11*
13	15*	12*

* Midway supports required for RAMPs longer than 9 sections.

BOARDWALK SYSTEM

SIDEWALK CLOSURE COMPONENTS:

In typical mid-block sidewalk closures, the curb lane is closed to vehicular traffic and used as a temporary pedestrian pathway. Pedestrians leave the sidewalk at one end, traverse the temporary pathway around the closure, and return to the sidewalk.

1. **SafetyWall** sidewalk closure features a “Sidewalk Closed” sign and a **Parakeet Audible Information Device (AID)**. The “Sidewalk Closed” sign directs pedestrians with vision to use the temporary pathway, while Parakeet broadcasts audible directions to pedestrians that are visually impaired.
2. **SafetyWall** provides accessible, detectable, continuous guidance and separates pedestrians from the sidewalk construction and the traffic lane. BoardWalk System then returns pedestrians to the sidewalk.
3. **BoardWalk System**, located at both ends of the pathway, provides an accessible, detectable, continuous curb transition for pedestrians, especially those that are BVI.
4. **LaneGard 3™ Folding Type III Barricade** advises vehicular traffic that the curb lane is closed. (See section X to learn more about our barricades.)

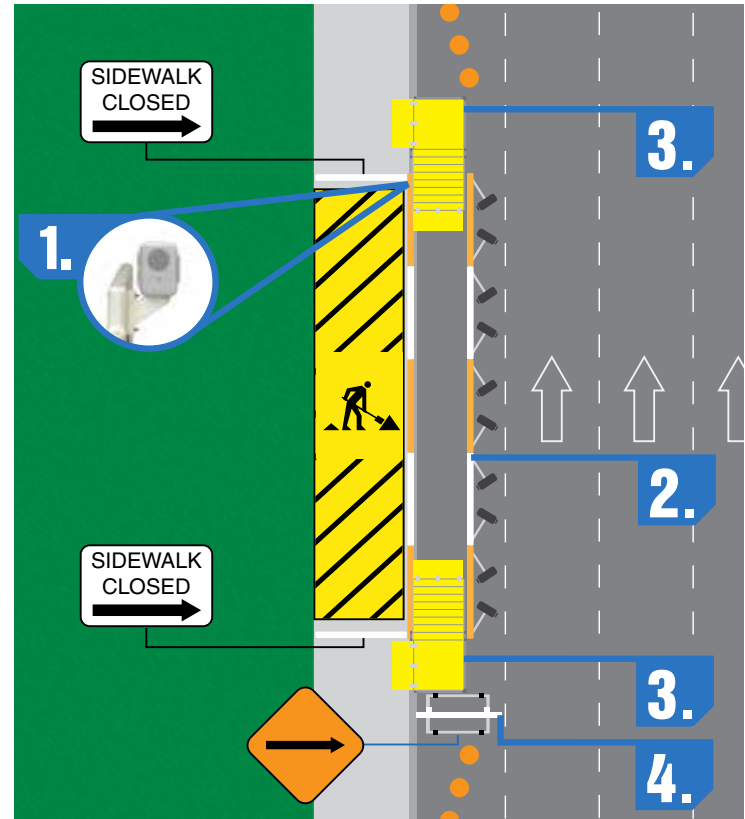

COMMON BOARDWALK CONFIGURATIONS

COMMON BOARDWALK RAMP CONFIGURATIONS

The BoardWalk System is a modular design to be compatible in various types of workzones and obstacles. While there are many ways to arrange BoardWalk, below are the five most common configurations of the BoardWalk RAMP or BoardWalk System.

1. Eight Section BoardWalk Ramp (No Handrails) (6" curb height)
2. Eight Section BoardWalk Ramp (Full Handrails) (6" curb height)

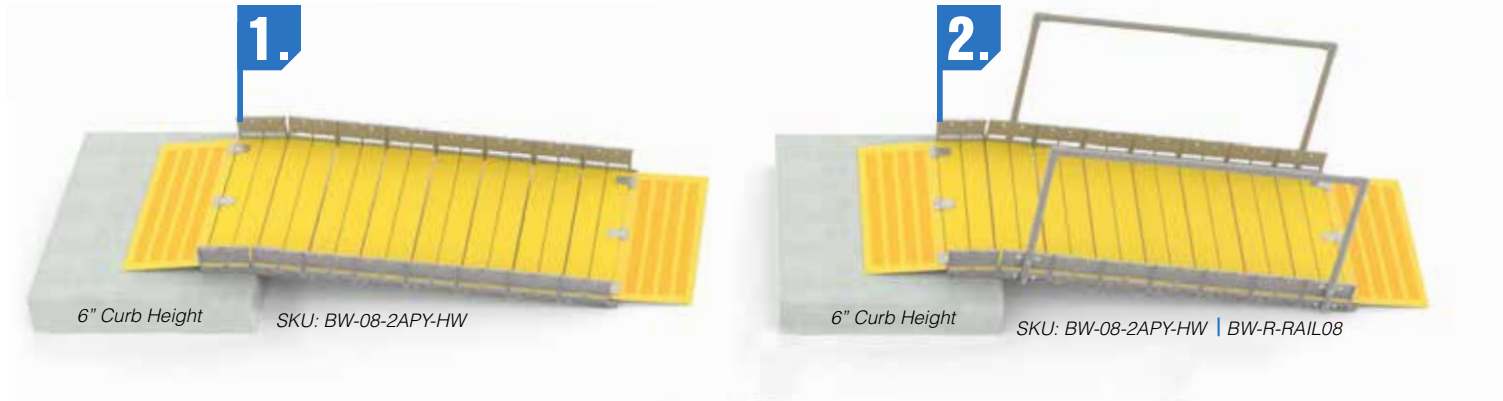

COMMON BOARDWALK CONFIGURATIONS

COMMON BOARDWALK SYSTEM CONFIGURATIONS

3. Five Section BoardWalk Ramp and Platform (No Handrails) (6" curb height)
4. Five Section BoardWalk Ramp and Platform (Handrails on the Platform and one section of the Ramp) (6" curb height)
5. Five Section BoardWalk Ramp and Platform (Full Handrails) (6" curb height)

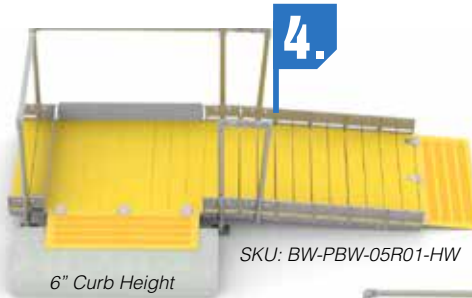
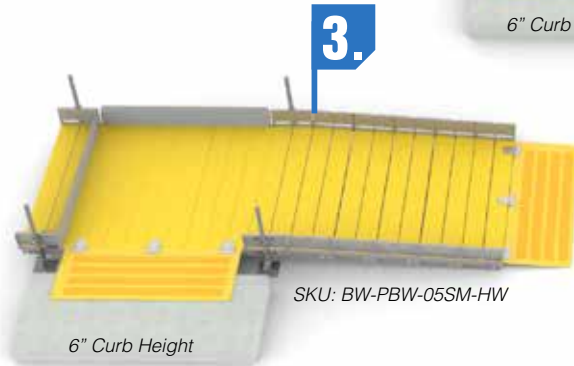

BOARDWALK BRIDGE

BOARDWALK BRIDGE FEATURES:

PSS BoardWalk Temporary Pedestrian Modular RAMP with Platform provides ADA-Compliant temporary pathways over curbs in sidewalk work zones.

Because of its modular design, we can create BoardWalk RAMP and Platform in several configurations while maintaining the ADA slope requirement of 1:12.

BoardWalk Bridge satisfies a new application: it provides a temporary pathway over an obstruction that is perpendicular to the sidewalk and street.

For the application shown in the graphic, Figure A, BoardWalk Bridge is installed on the sidewalk, parallel to it, and over the hazard. The height of the hazard and the ADA slope requirement determine BoardWalk Bridge's length. Figure B shows Midway supports, which are required for RAMPs longer than nine sections.

To discuss your custom BoardWalk Bridge application, please contact us at **800.662.6338**.

A.

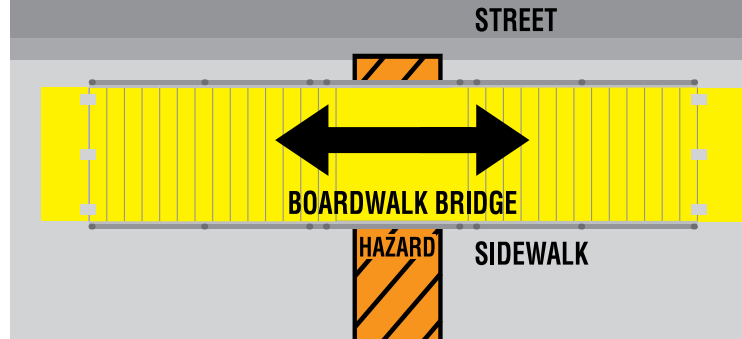

B.



BOARDWALK BRIDGE

BOARDWALK BRIDGE COMPONENTS:

All components, except Numbers 5 and 6, are used on both sides of BoardWalk Bridge.

1. Approach Plate
2. Handrail Upright
3. BoardWalk RAMP Sections
4. Jack Screw Upright
5. BoardWalk Platform
6. Platform Detectable Edge
7. Midway Support
8. Modular Edge Support Castings

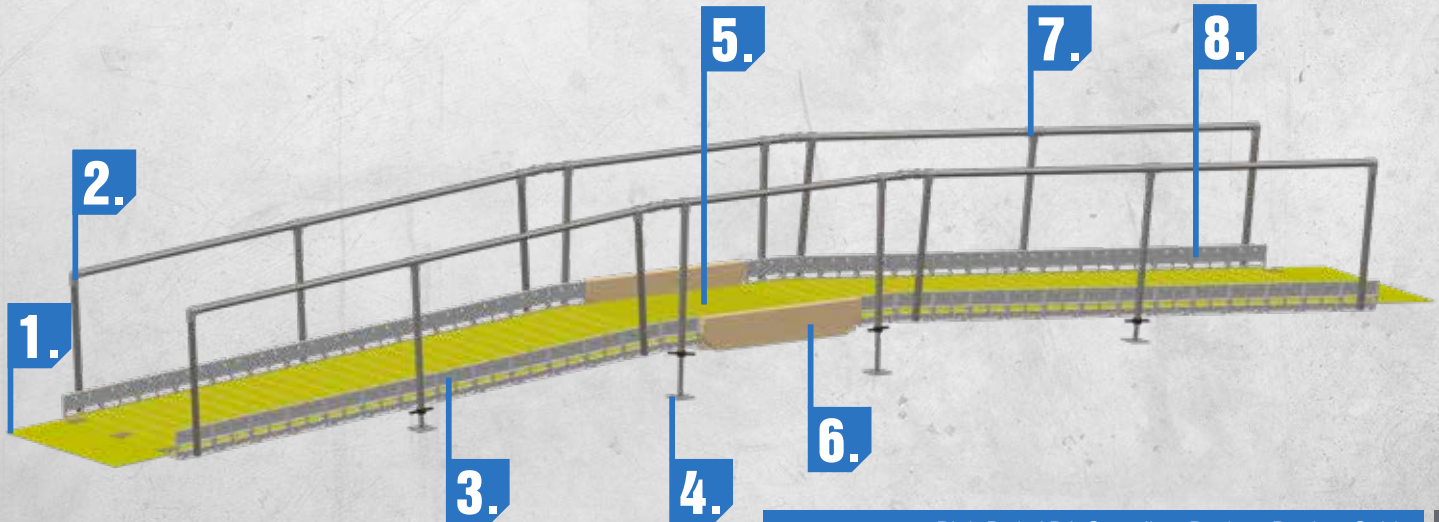

RAPIDRAMP THE EXPRESS ADA RAMP

RAPIDRAMP: THE EXPRESS ADA RAMP

Designed for up to a 6" curb*, RapidRamp can be deployed quickly and easily.

The RapidRamp is a portable, ADA-Compliant ramp engineered with a lightweight design that reduces installation and removal time. Consisting of six sections that easily interlock, **with no hardware required**, RapidRamp stores conveniently in truck beds and most vans.

RapidRamp delivers an immediate solution to overcome vertical challenges, including accessibility around short-duration job sites and transportation of heavy loads with a cart or dolly.

The RapidRamp is designed to deliver a firm, stable, and slip-resistant pathway over curb transitions.

RapidRamp is rated to a 1,000 lb. capacity, greatly increasing its practical applications. For shorter curbs, RapidRamp can be installed with fewer than six sections.

Patents: <http://bit.ly/3cHVTp8>



RAPIDRAMP THE EXPRESS ADA RAMP



RAPIDRAMP BENEFITS

- » Ramp consists of six sections with slip-resistant surfaces
- » Rated to support a load of 1,000 lbs.
- » Ramp mid-sections weigh approximately 22 lbs.
- » End-sections (with the approach lip) weigh 55 lbs.
- » Sections are 48" wide

RAPIDRAMP DIMENSIONS



MAXIMUM LENGTH (SIX SECTIONS)
79"

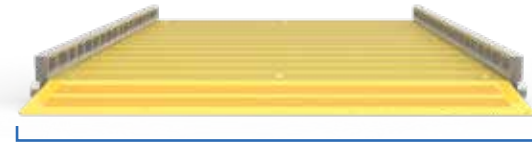

MAXIMUM WIDTH
48"



SAFETYWALL™ PEDESTRIAN BARRICADE

SAFETYWALL™ ADA-COMPLIANT BARRICADE:

Dimensions: 3" W x 36.25" H x 74" L

Weight: 35 lbs

Material: Made with high-density polyethylene with UV stabilizers to provide years of reliable service life. The foldable steel legs deliver increased stability with ballast.

SafetyWall is a continuous, interlocking device ideal for creating accessible work zones. Our barricade meets ADA guidelines and MUTCD 2009 Edition as a sidewalk closure barricade or longitudinal channelizer. SafetyWall provides the same level of pedestrian guidance as concrete or water-filled barrier, but is easier to transport, install, and remove.

SafetyWall accepts retroreflective sheeting, meeting all ASTM D4956-19 specifications, on one or both sides.



SAFETYWALL™ FEATURES:

1. SafetyWall provides continuous guidance. Hand-Trailing top is smooth, safer for hand guidance.
2. Accepts Audible Information Devices, Warning Lights.
3. SafetyWall is an interlocking device. Assembles quickly. No tools required. A two-person crew can easily create an accessible work zone in minutes.
4. Centrally located carry handle allows for easy transport of one or two SafetyWall units.
5. The nesting feature provides for convenient stacking and storage.
6. Continuous bottom for guidance with cane. Gap between bottom of unit and ground is less than 2", reducing potential for trapping cane tips.
7. Common vertical plane eliminates obstacles in the walkway for safer, continuous guidance.
8. Legs fold in for easy storage. Recessed bottom edge allows for easy deployment of both legs.

Patents: <http://bit.ly/3cHVTp8>

SAFETYWALL™ PEDESTRIAN BARRICADE



SAFETYRAIL™ PEDESTRIAN BARRICADE

SAFETYRAIL™ ADA-COMPLIANT BARRICADE:

SafetyRail is a continuous, interlocking device designed for creating accessible work zones. This device adheres to ADA guidelines and MUTCD 2009 Edition as a sidewalk closure barricade and longitudinal channelizer.

SAFETYRAIL FEATURES:

1. Audible Information Device or Warning Light Mount.
2. SafetyRail provides continuous hand guidance using the Wave™ Guide Rail.
3. Oversized fill hole for internal sand ballast.
4. Top and bottom bushings hold Wave Guide Rail in place. No installation tools required.
5. Molded-in lug for easy stacking also located by the fill hole and the molded handle.
6. Common vertical plane eliminates obstacles in the walkway for safer, continuous guidance.
7. Molded handle for easy transport.
8. Support for optional ballast.
9. Measures 1.5" from ground, reducing potential for trapping cane tips.

Patents: <http://bit.ly/3cHVT8>

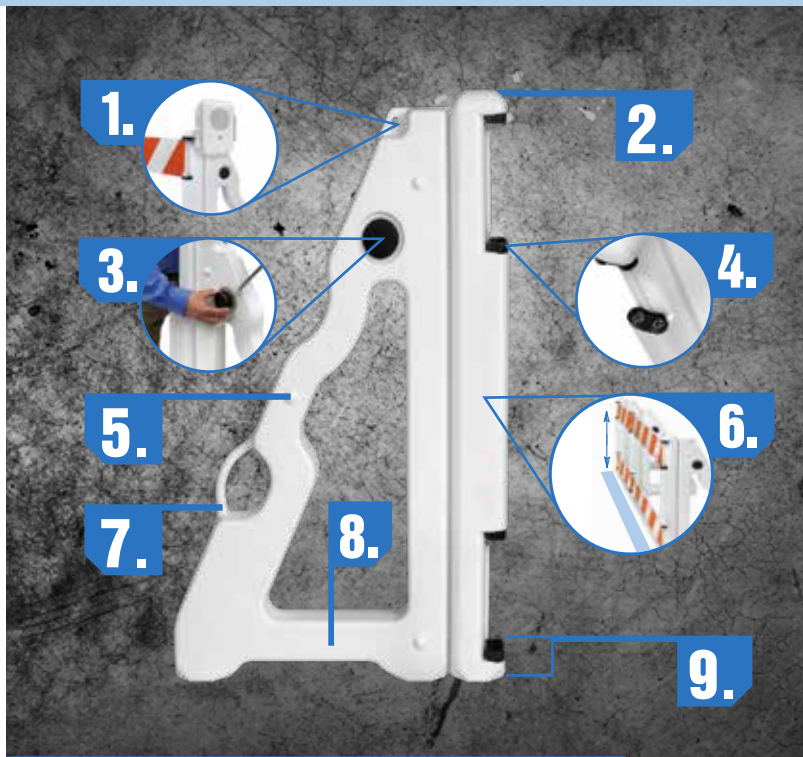

FHWA ELIGIBILITY LETTER:

Letter: WZ-359

Tested to Manual for Assessing Safety Hardware
(MASH) Test Level: 3

SAFETYRAIL™ PEDESTRIAN BARRICADE

SAFETYRAIL FEATURES:

Dimensions: 3.25" W x 38" H x 24" L at base

Weight: 7 lbs empty or up to 25 lbs of ballast

Material: High-density polyethylene and UV inhibitors

PSS WAVE GUIDE RAIL:

Made from high-density polyethylene with UV inhibitors and is available in four-foot or six-foot lengths. Encapsulated ends eliminate cane or hand snagging hazards.

Wave Guide Rail accepts retroreflective sheeting, meeting all ASTM D4956-19 specifications, on one or both sides.



SafetyRail is designed for use with PSS Wave™ Guide Rail. The upper Wave Guide Rail is smooth, continuous, and safe for trailing of the hand. The lower Wave Guide Rail measures 1.5" from the ground, reducing potential for trapped cane tips. Wave "notch" design keeps guide rails securely in bushings.

PARAKEET AID

PARAKEET BENEFITS:

The Parakeet™ is an Audible Information Device (AID) designed for custom messaging with a built-in speaker and microphone.

When roads and sidewalks are closed, Parakeet allows for up to 60-seconds of pre-recorded instructions to the alternate path for visually impaired pedestrians.

The device recording is motion activated, responding to pedestrians as they approach. This motion detection is customizable, allowing for longer or shorter fields of detection as needed. Additionally, the built-in microphone automatically adjusts its decibel level based on surrounding noise throughout the day.



Patents: <http://bit.ly/3cHVT8>

PARAKEET AID

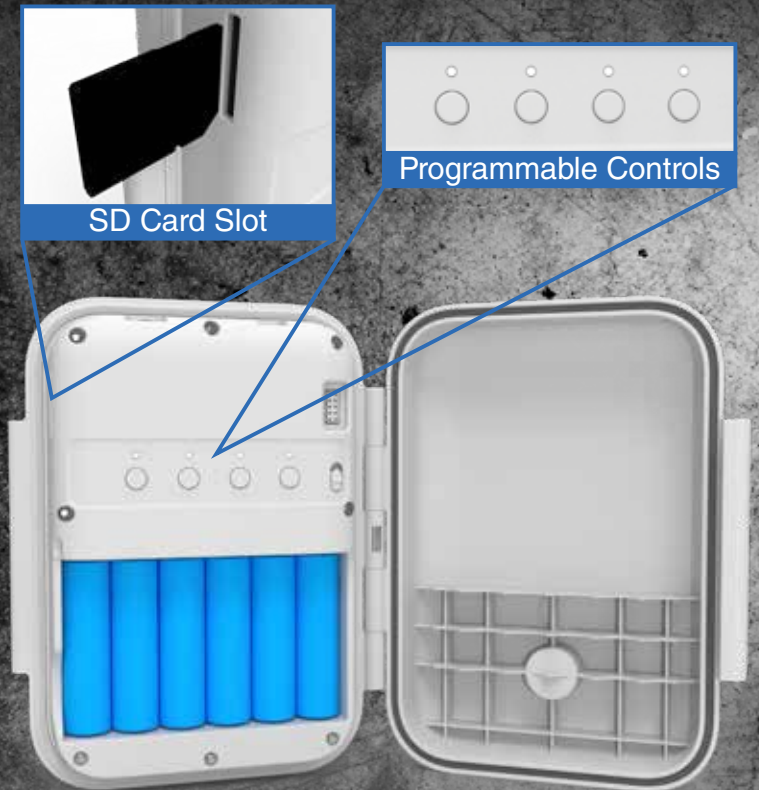

PARAKEET FEATURES & BENEFITS:

- » Motion detection
- » Automatic decibel adjustment
- » Up to 60-second recording
- » Mounts to a standard traffic control devices
- » Rechargeable batteries
- » Water resistant housing
- » Tamper resistant casing



NOTES

Follow us on:



We are a proud member of:

